







Kabelkonfigurator

PADCON Float Controller CI

Kabelvarianten

Kabel Nr.	Kabel Typ	Länge	Anschlüsse	Beschreibung
①		0,5m	offen / MC4 Stecker	Anschlusskabel Wechselrichter (Messung + / Pull up)
②		1m	MC4 Buchse / MC4 Stecker	Verbindungskabel mit eingegossener 5A Sicherung (Modulseite mit positiver Spannung)
③		3m / 5m / 10m	MC4 Buchse / MC4 Stecker	Distanzkabel (Messung + / Pull up)
④		0,5m	MC4 Buchse / MC4 Stecker	Verbindungskabel FC zu MC (Pull up)
⑤		0,5 m / 3m / 5m / 10m	offen / MC4 Buchse	Anschlusskabel Wechselrichter (Messung -)
⑥		3m / 5m / 10m	offen / MC4 Stecker	Anschlusskabel Wechselrichter (Messung + / Pull up)
⑪		0,4m	MC4 Stecker / MC4 Stecker MC4 Buchse	Y- Kabel +

Bestellung

Kabel Nr.	Länge	Anzahl

Kabel Nr.	Länge	Anzahl

Bitte senden Sie dieses Formular ausgefüllt per Fax, Post oder Email an PADCON GmbH.

PADCON GmbH
Steigweg 24 / Geb. 44
97318 Kitzingen

Tel.: +49 (0) 9321 2680 - 200
Fax: +49 (0) 9321 2680 - 9200
E-Mail: info@padcon.de
Home: www.padcon.de

Kabelkonfigurator

PADCON Float Controller CI

Float Controller

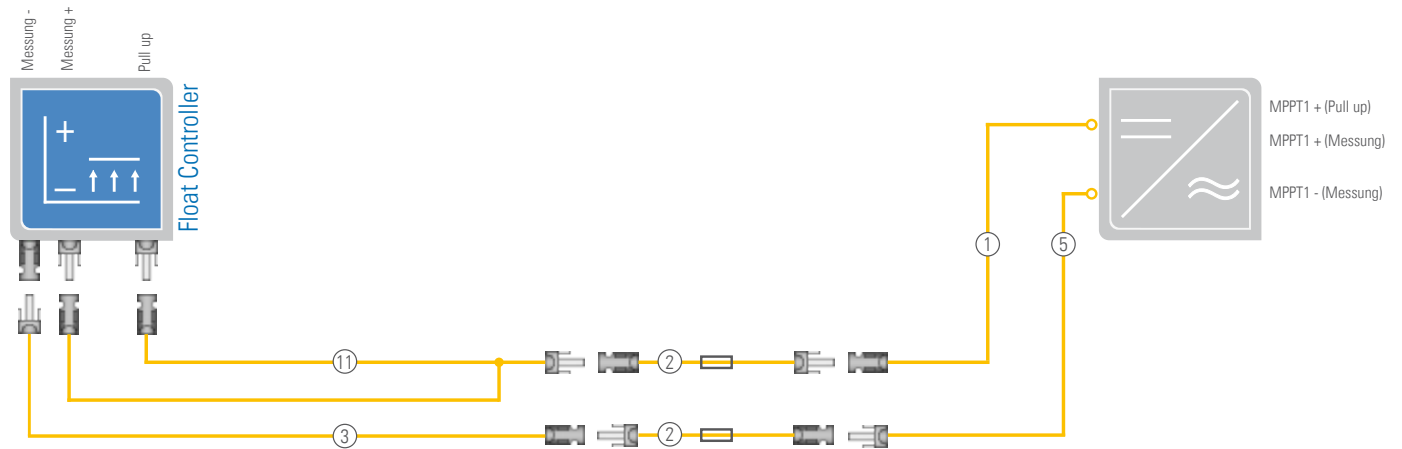

Float Controller mit Multi Connector

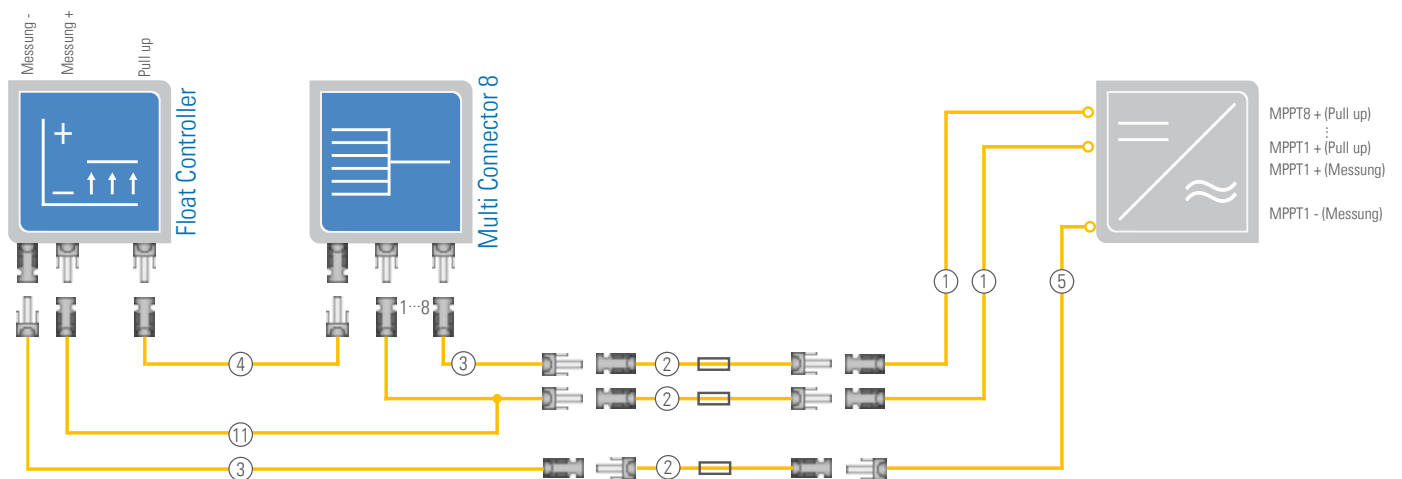

Compact Station

